

Aria

Air to water heat pump

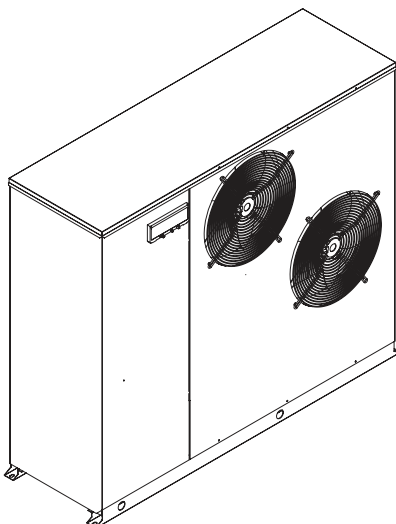

Installation & Servicing Instructions

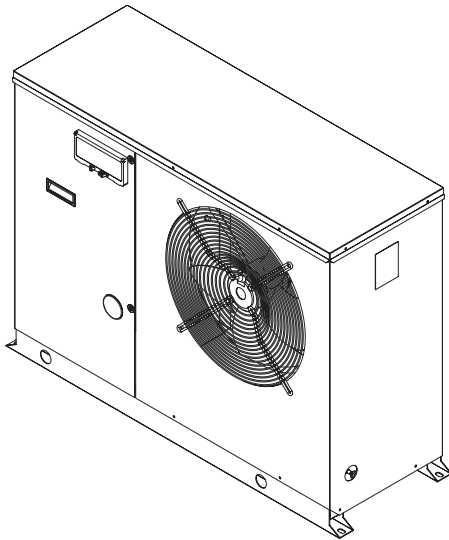

**THESE INSTRUCTIONS
TO BE RETAINED
BY USER**



Vokèra is a licensed member of the Benchmark scheme which aims to improve the standards of installation and commissioning of domestic hot water systems in the UK.

BUILDING REGULATIONS

This appliance must be installed and serviced only by a competent person in accordance with the current: IEE Regulations, Building Regulation, Building Standards (Scotland) (Consolidation), Building Regulations (Northern Ireland), local water by-laws, Health & Safety Document 63S (The Electricity at Work Regulations 1989), IS 813 (Eire) and other local requirements.

The relevant Standards should be followed, including:

BS EN 15450: Heating systems in buildings – Design of heat pump heating systems.

BS EN:12828 : Central heating for domestic premises.

BS EN 7593 : Treatment of water in domestic hot water central heating systems.

BS EN 14511 : Requirements heat pumps for space heating and cooling.

BS EN 378 : Safety and environmental requirements for heat pumps.

The Health and Safety at Work Act 1974.

The Management of Health and Safety at Work Regulations 1999.

The Construction (Health, Safety and Welfare) Regulations 1996.

The Construction (Design and Management) Regulations 1994.

The Lifting Operations and Lifting Equipment Regulations 1998.

Where no specific instruction is given, reference should be made to the relevant codes of Practice.

There have been no banned substances used in the manufacture of these appliances.

INDEX

1 GENERAL

.....	5
1.1 GENERAL PRECAUTIONS	
.....	5
1.2 FUNDAMENTAL SAFETY RULES	
.....	5
1.3 DESCRIPTION OF THE APPLIANCE	
.....	6
1.4 IDENTIFICATION	
.....	7
1.5 TECHNICAL DATA	
.....	8
1.6 HYDRAULIC DATA	
.....	9
1.7 ACCESSORIES	
.....	9
1.7.1 Electric heater	
.....	9
1.8 HEAT PUMP COOLING CIRCUIT	
.....	10
1.9 ELECTRICAL PANEL AND WIRING DIAGRAM	
.....	10
1.9.1 ARIA 6HP / 8HP Models	10
1.9.2 ARIA 11HP Model	12

2 INSTALLER

.....	13
-------	-----------

2.1 CONTROL PANEL	
.....	13
2.2 ACTIVATION & DEACTIVATION	
.....	15
2.2.1 Heating / Cooling activation	
.....	15
2.2.2 Heating / Cooling deactivation	
.....	16
2.3 OPERATIONS PERFORMED WITH THE REMOTE ON-OFF “SO” and SUMMER-WINTER “SEI” SWITCHES	
.....	17
2.3.1 Cooling function	
.....	17
2.3.2 Heating function	
.....	17
2.4 SHUTDOWN FOR LONG PERIODS	
.....	17
2.5 CLEANING	
.....	17
2.6 MAINTENANCE	
.....	17
2.7 USEFUL INFORMATION	
.....	18
2.8 RECEIVING THE PRODUCT	
.....	18
2.9 DIMENSIONS WITH PACKAGING	
.....	18
2.10 DIMENSIONS WITHOUT PACKAGING	
.....	19

2.11 HANDLING AND TRANSPORT	19
2.12 POSITIONING	20
2.12.1 Fixing position of dampers	21
2.13 HYDRAULIC CONNECTIONS	22
2.14 POSITION OF THE FIXINGS	24
2.15 ELECTRICAL CONNECTIONS	24
2.16 OUTSIDE CONNECTIONS AND ELECTRICAL POWER CABLE INFEED	25
2.17 LOADING AND EMPTYING THE SYSTEM	27
2.17.2 Loading	27
2.17.2 Emptying	44

3 TECHNICAL SERVICE

..... 28	
3.1 RECOMMENDED OPERATING CONDITIONS	28
3.2 LIMIT OPERATING CONDITIONS	28
3.3 PREPARATION FOR THE FIRST STARTING UP	29
3.4 FIRST START-UP	29
3.6 ACTIVATION OF "SO" AND "SEI" CONTROL	30
3.6.1 Setting the "SO" remote control	30

3.6.2 Setting the "SEI" remote control	30
3.7 ANOMALY SIGNALS	30
3.7.1 Manual anomaly reset	31
3.8 ACTIVATION and DEACTIVATION OF THE UNIT	31
3.9 OPERATIONS PERFORMED BY THE ON-OFF "SO" AND SUMMER-WINTER "SEI" REMOTE SWITCHES	33
3.10 DEFROSTING CHECK	34
3.11 CONTROLS DURING AND AFTER THE FIRST START-UP	34
3.12 LONG TERM SHUTDOWN	34
3.13 ROUTINE MAINTENANCE	34
3.14 EXTRAORDINARY MAINTENANCE	34
3.14.1 Loading coolant gas	34
3.14.2 Compressor	35
3.15 DISPLAY AND CONTROL PARAMETERS	35
3.15.1 Main parameters and variable characteristics	35
3.15.2 Access and modification of parameters	35
3.16 TROUBLESHOOTING	36

The following symbols are used in some parts of the booklet:



ATTENTION = for actions that require special precautions and an adequate preparation



FORBIDDEN = for actions that must NOT be carried out

1.1 GENERAL PRECAUTIONS



After removing the packing, check the integrity and completeness of the contents. If they do not correspond, contact the **Vokera** agency that sold the unit.



Vokera appliances must be installed by companies that are enabled in accordance with legislations in force, and on completion of the work, a declaration of conformity must be given to the owner certifying that the installation has been done correctly and in accordance with the legislation in force and the indications given by **Vokera** in the instruction booklet supplied with the appliance.



These appliances have been built for heating or climatisation of environments and must be destined for this use, compatibly with their performance characteristics.



The manufacturer accepts no responsibility, either contractual or extra contractual, for damage to persons, animals or property arising from incorrect installation or adjustment, maintenance or improper use.



Should water leak from the unit, turn the unit master switch to "OFF" and close the water taps. Urgently call the **Vokera** service department or professionally qualified personnel and under no circumstances intervene personally on the unit.



These units contain R410A refrigerant gas; take great care not to damage the gas circuit and the finned battery. If the refrigerant gas escapes, set the system master switch to "OFF" and call immediately the **Vokera** technical service, or other qualified personnel; do not intervene personally on the unit.



If the equipment is not used for a long period, the following operations should be carried out:

- Turn the system master switch to "OFF"
- Close the water taps
- If there is the risk of freezing, make sure that anti-freeze liquid has been added, otherwise empty the system.



This instructions booklet is an integral part of the unit and consequently must be kept with care and must ALWAYS accompany the unit, even when this is transferred to another owner or user or transferred onto another system. If it gets damaged or lost, request another copy from the local **Vokera** technical service.



Repair or maintenance interventions must only be carried out by the **Vokera** technical service or personnel qualified according to the provisions of this manual. Do not modify or tamper with the unit as this could cause situations of danger and the manufacturer shall not be responsible for any damaged caused.

1.2 FUNDAMENTAL SAFETY RULES

The use of products that use of electricity and water requires the observation of some fundamental safety rules such as:



Do not allow children to operate this unit.



Do not touch the unit if barefoot or with parts of the body that are wet or humid.



Do not clean the unit without first disconnecting it from the mains power supply by switching the system master switch to "OFF".



Do not modify or adjustment units without authorisation and the indications of the manufacturer.



Do not pull out or twist the electric cables coming out of the unit, even when disconnected from the mains power supply.



Do not introduce objects or substances through the aspiration grills or the air outlets



Do not open the access flaps to the inner parts of the unit without first having set the system master switch to "OFF".



Do not leave the packaging material within the reach of children as it can be a source of risk.



Before undertaking any maintenance intervention on the unit, it is compulsory to cut "OFF" the mains electrical supply by setting the double pole master switch on the system to "OFF".



Do not spray or tip water directly onto the unit.



Do not climb onto the unit or rest any object on it.

1.3 DESCRIPTION OF THE APPLIANCE

The **Vokera ARIA** heat pumps are available with single phase power supplies, capable of producing both hot water for heating and cold water for cooling domestic, residential environments and equipped with supplementary electrical resistances which allow correct functioning even in the most critical environmental conditions. They are best suited for under floor heating or low temperature systems. They use an internal Scroll type rotary compressor mounted on anti-vibration supports

and located in a special compartment, electronically controlled variable speed helical fans that ensure silent high performance. The user side plate exchanger in AISI 316 stainless steel is insulated with an anti-condensation coating and fitted with a flow regulator. The units are fitted with various safety devices such as pressure switches, flow gauge, sensors, specific circuit breakers etc. An electronic device with microprocessor control manages the operation. The models are supplied with inertial storage built into the unit.

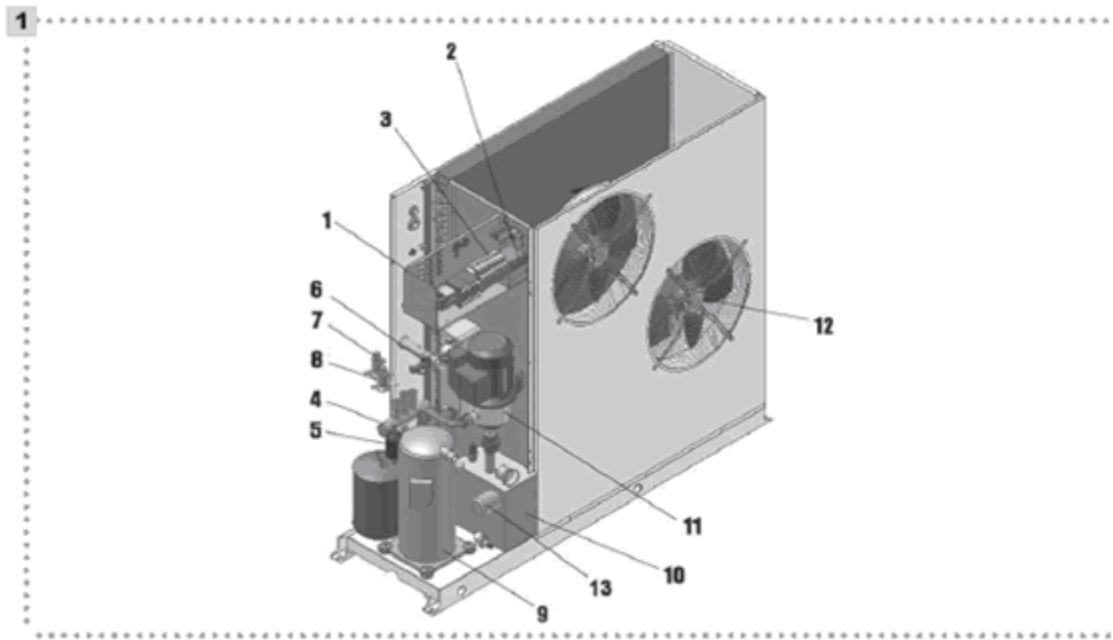

Legend fig. 1

1	Electrical panel	8	Expansion valve (winter)
2	Control panel	9	Scroll compressor
3	Thermo magnetic switch	10	Hydraulic kit
4	4 way-valve	11	Pump
5	Dehydrator filter	12	Axial fan
6	Flow switch	13	Electric heater
7	Expansion valve (summer)		

1.4 IDENTIFICATION

The Vokera ARIA unit can be identified by:

- Technical plate (fig. 2) It indicates the technical and performance data of the unit.



The tampering with, removal or lack of the technical plate or anything else that makes a certain product identification impossible will make correct maintenance or installation operations more difficult.

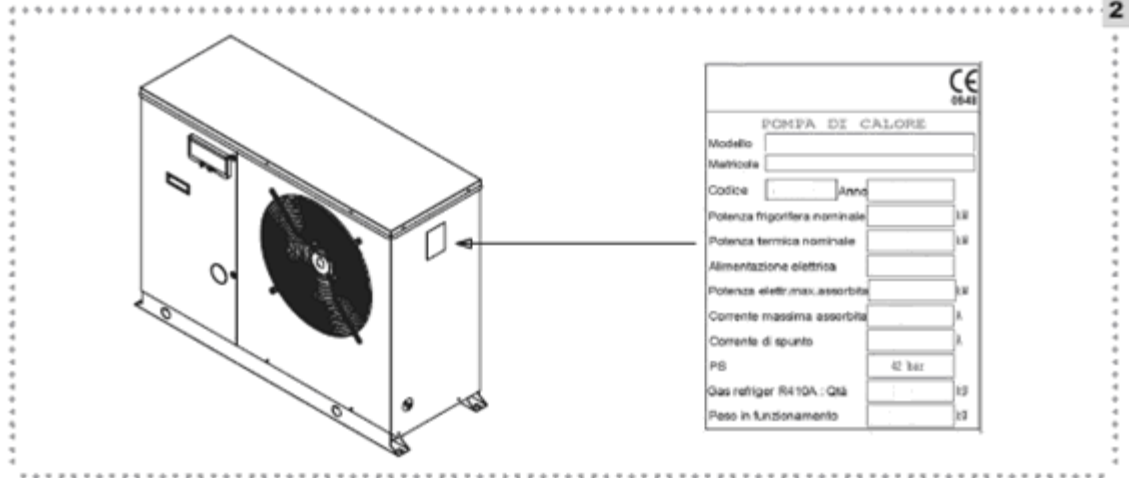

1.5 TECHNICAL DATA

DESCRIPTION	Models										
		6HP	8HP	11HP							
Thermal power (1)	kW	6.8	8.3	11.0	(1) outside air d.b. + 7°C / w.b. + 6°C, water 35-30°C.						
Absorbed power (1)	kW	1.74	2.11	2.81							
Thermal power (2)	kW	5.9	7.2	9.5	(2) outside air + 0°C, water 35 - 30°C						
Absorbed power (2)	kW	1.78	2.2	2.90							
Thermal power (3)	kW	5.0	6.2	8.0	(3) outside air - 7°C, water 35 - 30°C						
Absorbed power (3)	kW	1.79	2.26	2.97							
Thermal power (4)	kW	6.6	8.1	10.6	(4) outside air + 7°C, water 45 - 40°C						
Absorbed power (4)	kW	2.14	2.68	3.5							
Thermal power (5)	kW	5.6	7.1	9.3	(5) outside air + 0°C, water 45 - 40°C						
Absorbed power (5)	kW	2.16	2.77	3.6							
Thermal power (6)	kW	7.5	10.3	13.0	(6) outside air + 30°C, water 18 - 23°C						
Absorbed power (6)	kW	1.8	2.28	2.93							
Thermal power (7)	kW	6.9	9.3	11.8	(7) outside air d.b. + 35°C / w.b. +24°C, water 18 - 23°C						
Absorbed power (7)	kW	2.0	2.72	3.46							
Thermal power (8)	kW	6.0	8.2	10.2	(8) outside air + 30°C, water 7 - 12°C						
Absorbed power (8)	kW	1.76	2.34	3.01							
Thermal power (9)	kW	5.3	7.1	9.3	(9) outside air d.b. + 35°C / w.b. +24°C, water 7 - 12°C						
Absorbed power (9)	kW	2.04	2.81	3.58							
	Empty weight	Nominal water flow	Diameter hydraulic fittings	Tank capacity	Electric heater	Power voltage	Protection rating	Axial fan	Nominal air flow	Noise level	Refrigeration load
6HP	110kg	1.0 m³/h	¾"	16 litres	3kW	230~	IP44	1	3.300 m³/h	58db (A)	1.7kg
8HP	112kg	1.2 m³/h	¾"	16 litres	3kW	230~	IP44	1	3.250 m³/h	58db (A)	1.9kg
11HP	164kg	1.6 m³/h	1"	36 litres	6kW	230~	IP44	2	6.500 m³/h	62.8db (A)	2.7kg

1.6 HYDRAULIC DATA

The following diagram (fig. 3) indicates the residual prevalences with the nominal water flow $\pm 20\%$.

1.7 ACCESSORIES

The accessories indicated below must be ordered separately

ACCESSORIES CODE

Remote control Kit 4014762

Anti-vibration supports Kit 4015360

Snow protection 6HP – 8HP 4014763

Snow protection 11HP - 4014764

Soft Start Kit 4014766

Hot water thermostat kit 4014767

1.5 kW single phase electric heater 4383270

1.7.1 Electric heater

The electric heater is integrated into the heat pump to ensure continuity of service and is inserted through a special plug into the storage tank.

It is enabled to facilitate the compressor during the start-up phase (it keeps the water at a set temperature value (e.g. 30°C) and when the atmospheric conditions become particularly critical for correct machine operation (continual frost caused by the low temperature and excessive humidity).

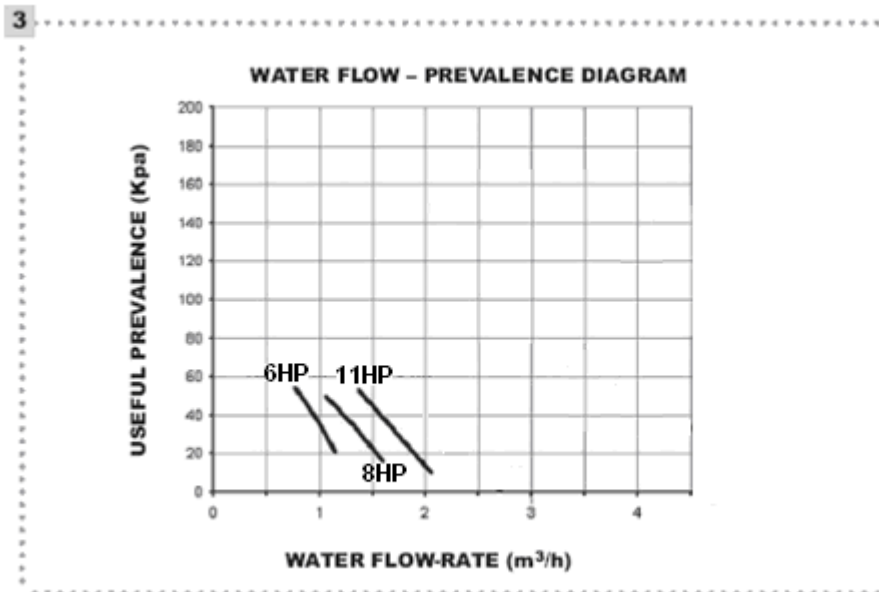

1.8 HEAT PUMP COOLING CIRCUIT

1	Fan	9	Plate exchanger
2	Finned battery (evaporator)	10	4 way-valve
3	Non-return valve	11	High pressure safety pressure-switch
4	Thermostatic valve (summer cycle)	12	Compressor
5	Thermostatic valve (winter cycle)	13	Liquids container
6	Filter	14	Low pressure safety pressure-switch
7	Fluid indicator	15	Pressure transducer
8	Flow switch	16	Safety valve

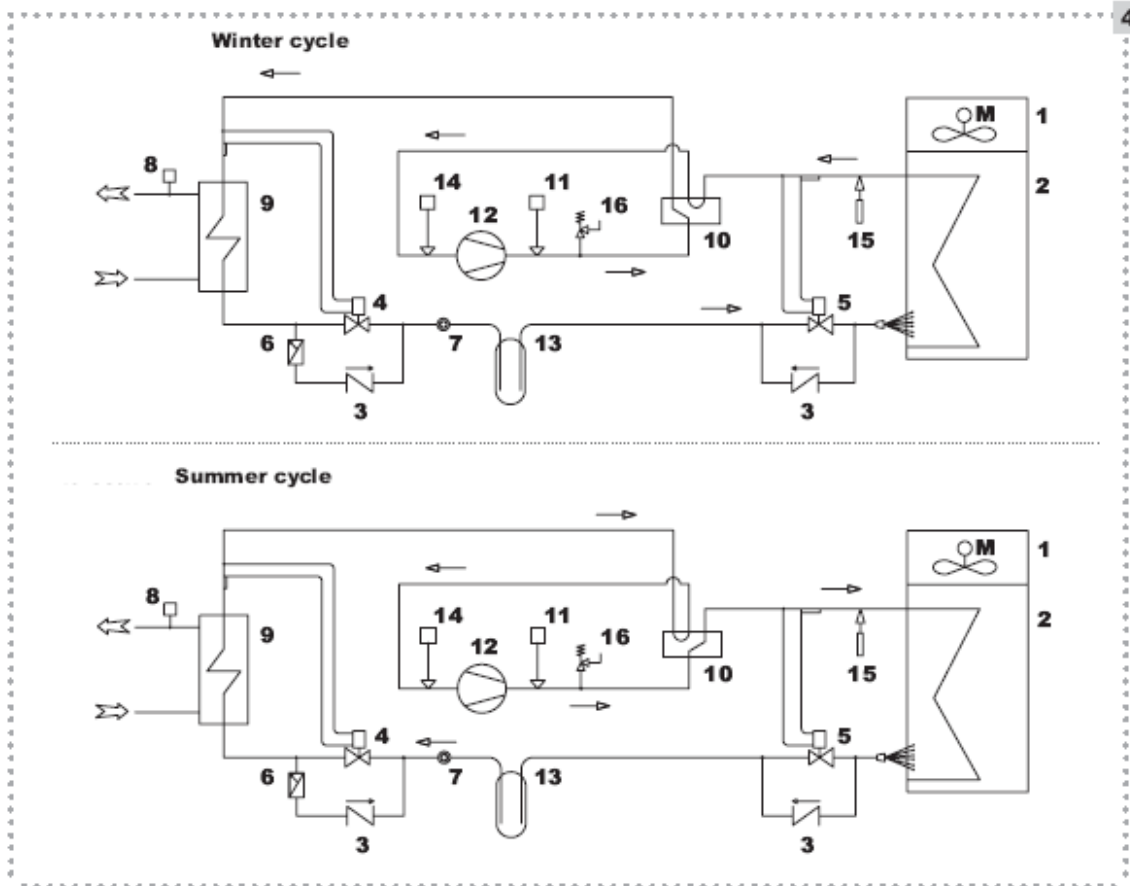

1.9 ELECTRIC PANEL AND WIRING DIAGRAM

1.9.1 ARIA 6HP / 8HP Models

Factory installed components

CM Run condenser
 CV1 Fan condenser
 KM1 Compressor contactor
 KM2 Resistance contactor
 MI Control panel
 Q1 Master circuit breaker
 Q2 Support resistance circuit breaker
 C Compressor
 F1 Control safety fuse
 F2 Pump safety fuse
 F3 Resistance safety fuse
 Conn.A Input terminal board
 Conn.B Loads output terminal board
 P Circulator

The units are equipped with an electric panel consisting of the following components:

PD Flow switch
 Tp Safety thermostat
 TR Auxiliary circuits transformer
 SP3 Pressure transducer
 ST1 Temperature probe in exchanger inlet
 ST2 Temperature probe in exchanger outlet
 ST4 Outside air temperature probe
 PA High pressure pressure-switch
 PB Low pressure pressure-switch
 VIC 4 way-valve
 Rp Plate exchanger resistance
 Rc Compressor cover resistance
 Rs Support resistance
 R1 / R2 Rp relay/boiler contact auxiliary relay
 V1 Fan

5

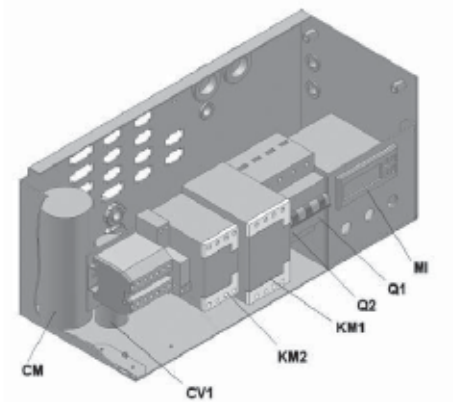

Components to mount on installation (not supplied with the unit)

AL Remote alarm signal (output 12V DC max 20mA)

FL Outside flow switch

SEI Remote SUMMER-WINTER switch

SO Remote ON-OFF switch

6

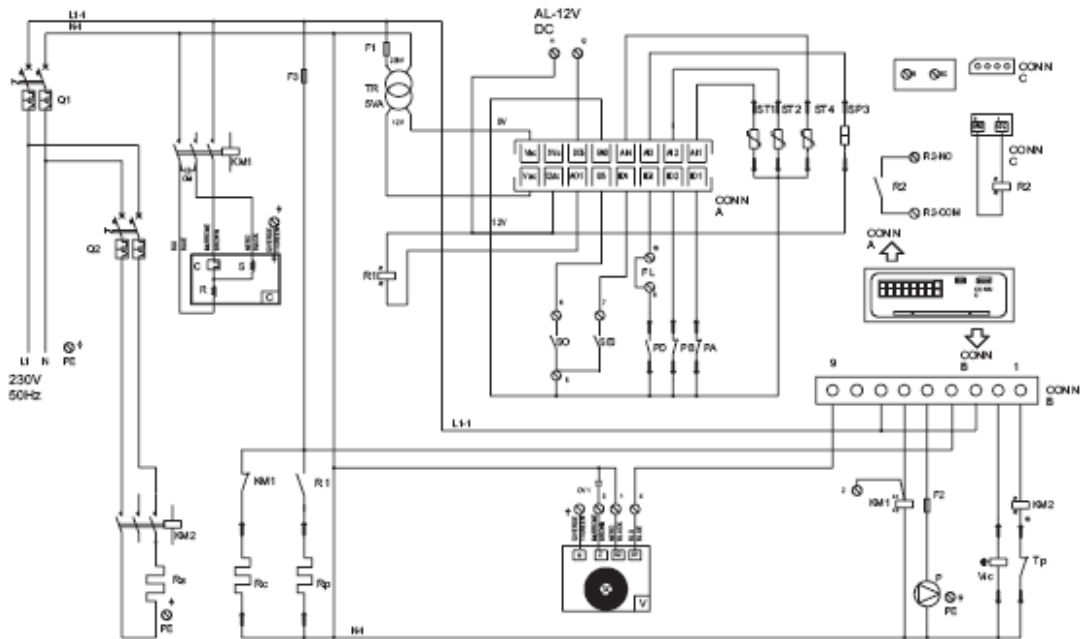

1.9.2 ARIA 11HP Model

Factory installed Components

CM Run condenser
CV1/2 Fan condenser
KM1 Compressor contactor
KM2 Resistance contactor
KM3 Pump contactor
MI Control panel
Q1 Master circuit breaker
Q2 Support resistance circuit breaker
C Compressor
F1 Control safety fuse
F2 Pump safety fuse
F3 Resistance safety fuse
Conn.A Inputs terminal board
Conn.B Loads output terminal board

P Pump / Circulator
PD Flow switch
Tp Safety thermostat
TR Auxiliary circuits transformer
SP3 Pressure transducer
ST1 Temperature probe in exchanger inlet
ST2 Temperature probe in exchanger outlet
ST4 Outside temperature probe
PA High pressure pressure-switch
PB Low pressure pressure-switch
VIC 4 way-valve
Rp Plate exchanger resistance
Rc Compressor cover resistance
Rs Support resistance
R1 / R2 Rp relay/boiler contact auxiliary relay
V1/2 Fan

7

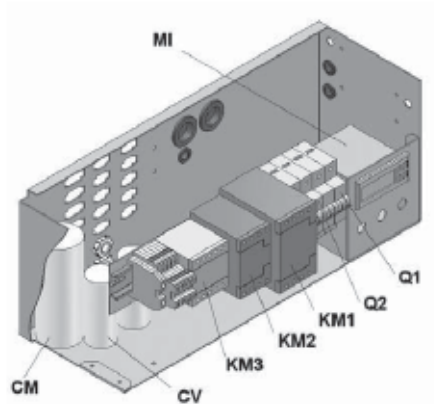

Components to mount on installation (not supplied with the unit)

AL Remote alarm signal (output 12V DC max 20mA)
FL Outside flow switch
SEI Remote SUMMER-WINTER switch
SO Remote ON-OFF switch

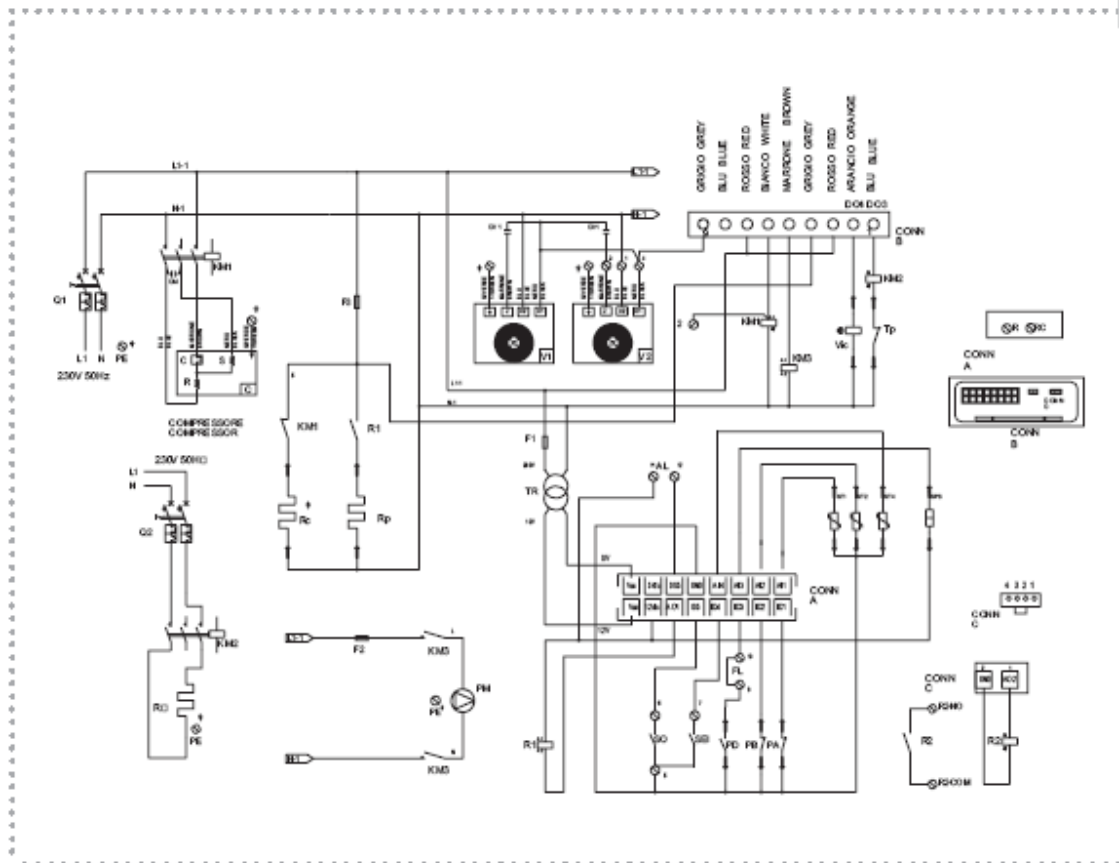

2.1 CONTROL PANEL

The control panel can be used to make all the adjustments necessary for the heat pump operation and display the values of the main parameters and the alarms. It is located on the front panel of the electric panel inside the unit and is accessible through a flap positioned on the inspection panel.

Display:

During normal operation it indicates the temperature of the water returning from the system.

It can also indicate the value of all the set parameters and the code of any alarms.

Fig. 15

- A** Alarm
- B** Mode (Heat, Cool, etc....)
- C** Economy (configurable)
- D** Clock
- E** Unit of measure
- F** Navigation in the menu
- G** Resources (Compressor, Fans, etc....)

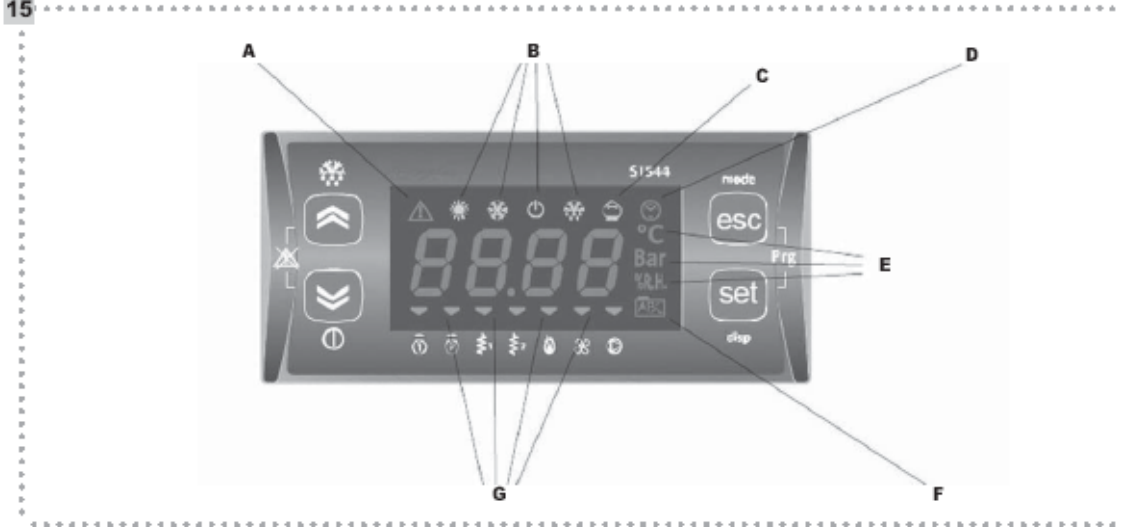

KEYS	Pressure with immediate release	Symbol printed on front panel	Prolonged pressure (if key is suitably configured)
	Scrolls the items in the menu, increases the values of the parameters		Defrosting request
	Scrolls the items in the menu, decreases the values of the parameters		Switching on/off of the unit (and vice versa)
	Manual alarm rearm		
	Access to machine status menu (setpoint, AI, DI, DO, hours completed, pump hours, etc...), access to submenus, access to parameter value, confirmation of parameter value	avail	Accesses the fundamental Display configuration file
	Exit from menu, parameters list, parameter value and return to upper level	mode	Accesses operating mode selection file (Heat/Cool/Std-by)
 	Accesses programming menu		

SET used for:

- Access to machine status menu
- Access to sub-menus
- Access to parameter value
- Confirmation of parameter value or exit
- prolonged pressure accesses the menu for the selection of the fundamental display (if the key is

configured for this function); with the up and down keys the options present can be displayed (with display based on the machine configuration) and pressure on the “set” key confirms the selection.

UP used for:



- scrolling up the display of files and parameters
- Increase of the parameter value (if in parameter value modification)
- Prolonged pressure accesses the function called manual defrosting (if the key is configured for this function), only from fundamental display.



DOWN  used for:

- Scrolling down the display of files and parameters
- Decrease of the parameter value (if in parameter modification)
- Prolonged pressure switches the unit on/off from fundamental display (if the key is configured for this function)

ESC  used for:

- Exit from the menu, from the parameters list, from the parameter value without saving the value and return to the previous level. Prolonged pressure from fundamental display (if the key is configured for this function) accesses the file for changing the mode; with the UP and DOWN keys displays the modes present (with display based on the machine configuration) and pressure on the SET key to confirm the selection made.

SET  +  ESC simultaneously to access the parameters, functions, password etc files.

UP  +  DOWN simultaneously to rearm alarms when present.

2.2 ACTIVATION AND DEACTIVATION

After the first start-up by the **Vokera** technical service the **ARIA** heat pump is adjusted for “automatic” operation and no other interventions are necessary. Therefore the plant manager must perform the ACTIVATION and DEACTIVATION

operations by intervening on the control panel or acting on the remote switch (if present).

To access the control panel, open the flap as follows:

- Remove the locking screw (fig. 16 ref. A)
- Simultaneously press on points B (fig. 16 ref. B) and lift the flap (fig. 16 ref. C)

When operations on the control panel are completed:

- Close the flap and reposition the locking screw.

 After powering up the unit, “OFF” will appear on the display.



Press the  key to enable the machine in stand-by, now the circulation pump should switch on and the display will show the temperature of water returning from the system.

Now proceed as follows:

2.2.1 Heating/cooling activation

To select the operating mode hold down the

 key until the message “HEAT”, “COOL” or “STBY” appears, according to the current operating status of the controller.



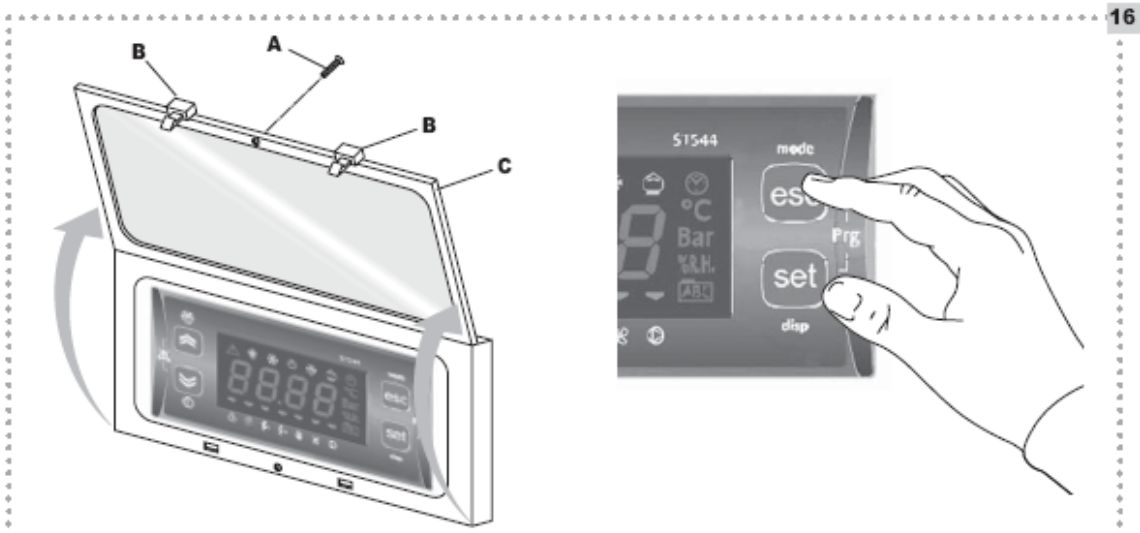

Select with UP  or DOWN  the HEAT function and confirm with the SET  key.

Heating (WINTER CYCLE) -By selecting HEAT the  symbol lights up.

Cooling (SUMMER CYCLE) -By selecting COOL the  symbol lights up.



2.2.2 Heating/cooling deactivation

Keep  pressed for a few seconds until the message “COOL” or “HEAT” appears (cycle enabled). Select with the  “STBY” key and confirm with the SET  key; the  symbol lights up.

 To change the Heating/Cooling operating mode on the heat pump models, it is advisable to call the Vokera technical service.

2.3 OPERATIONS PERFORMED WITH THE REMOTE ON-OFF “SO” and SUMMERWINTER “SEI” SWITCHES (IF PRESENT).

2.3.1 Cooling function

Activation

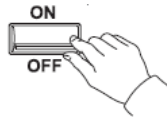

- Position the SUMMER-WINTER remote switch (SEI) to “OFF”.

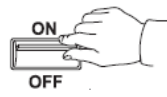

- Position the ON-OFF remote switch (SO) to “ON”.



The warning LED on the control panel lights up.

Deactivation

- Position the ON-OFF remote switch (SO) to “OFF”.



The message “OFF” appears and

flashes on the CONTROL PANEL.

2.3.2 Heating function

Activation

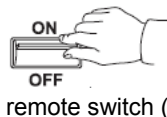

- Position the SUMMER-WINTER remote switch (SEI) to “ON”.

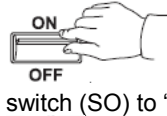

- Position the ON-OFF remote switch (SO) to “ON”.



The warning LED lights up on the control panel.

Deactivation

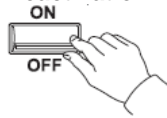

- Position the ON-OFF remote switch (SO) to “OFF”.



The message “OFF” flashes on the CONTROL PANEL.



In case of a power failure lasting more than four hours, when power returns, keep the unit powered but deactivated for at least eight hours.



In case of a power failure lasting less than four hours, when power returns, keep the unit powered but deactivated for the same number of hours that the power was out.

2.4 SHUTDOWN FOR LONG PERIODS

If the **ARIA** heat pump is not used for a long period, the following operations should be performed:

- From the control panel, deactivate the unit in whichever mode it is operating in.
 - Position the remote switch to “OFF” (if present)
- After deactivating the unit:
- Deactivate the indoor terminal units by setting the switch on each appliance to “OFF”.
 - Set the system master switch to “OFF”.
 - Close the water taps.



If there is a possibility that the outside temperature falls below zero there is a risk of freezing.

The hydraulic system **MUST BE EMPTIED** or else antifreeze liquid (e.g. ethylene glycol) must be added in the doses suggested by the manufacturer of the liquid. It is advisable to contact the Vokera technical service.



To start the unit up again after a long period of inactivity, contact the Vokera technical service.

2.5 CLEANING

The only essential cleaning that the plant manager needs to perform is on the outside panels of the cooler; this should be done with a cloth and soap and water. For persistent stains damp the cloth with a solution of 50% methylated spirit or a specific product in water. When the cleaning is completed, carefully dry the surfaces.



Do not use sponges with abrasive products or powder detergents.



Do not perform cleaning operations until the unit has been disconnected from the mains power supply by turning the master switch on the system to “OFF”.

2.6 MAINTENANCE

Routine maintenance is indispensable to maintain the efficiency, safety and reliability over the years. This can be carried out every six

months, for some interventions and annually for others, by a competent person or by the Vokera technical service that is technically prepared and authorised and always has original spare parts available when necessary.



For installations close to the sea, perform the maintenance interventions twice as often.



Before starting any maintenance intervention on the unit, it is compulsory to cut off the mains power supply by turning the double pole master switch on the system to "OFF"

2.7 USEFUL INFORMATION

Vendor:

.....

Address

.....

Tel.

.....

Installer:

.....

Name.

.....

Address

.....

tel.

.....

Technical service and assistance:

.....

Name.

.....

Address

.....

Dimensions (mm)	6HP 8HP	11HP
L (mm)	1040	1240
H (mm)	805	1000
P (mm)	378	428
L1 (mm)	1100	1300
P1 (mm)	425	472
P2 (mm)	890	1040

tel.

.....

DATE INTERVENTION

2.8 RECEIVING THE PRODUCT

The **ARIA** heat pumps are delivered in a single package on a wooden pallet, protected by cardboard packaging and accompanied by:

- instruction manual
- warranty certificate
- label with bar code
- first start up
- spare parts list.



The instruction manual is an integral part of the unit and it should be read and then kept with care.



It is advisable to position the unit in the place of installation before removing the packaging.



Do not dump packaging materials in the environment or leave them within reach of children as they are potentially dangerous.

2.9 DIMENSIONS WITHOUT PACKAGING

See page 8 for the weights.

Return / inlet (inch)	3/4"	1"
Reintegration (inch)	1/2"	1/2"

- P2: Dimensions with snow protection

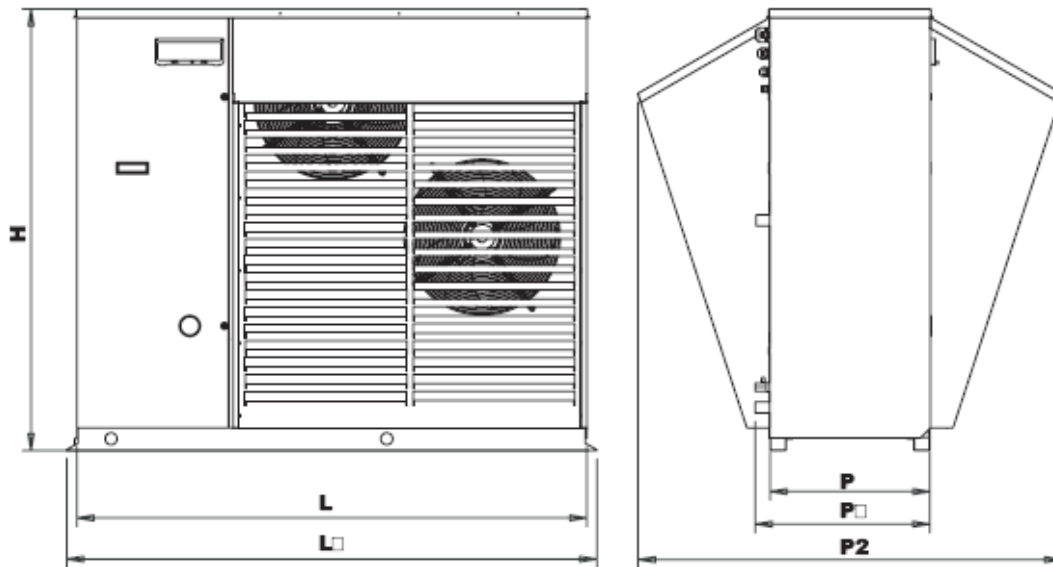

2.10 DIMENSIONS WITH PACKAGING

Dimensions (mm)	6HP 8HP	11HP
L (mm)	1140	1340
H (mm)	950	1150
P (mm)	480	540

2.11 HANDLING AND TRANSPORT

The handling and transport must always be carried out with the unit in a horizontal position. If a fork lift truck is used, insert two metal pipes in the special holes in the base and use suitable lifting means. If a crane is used, pass the ropes in the upper part of the wooden base taking care not to apply pressure on the unit (fig. 18).

It is advisable to position the unit in the place of installation before removing the packaging.

When the packaging has been removed, handling is done by inserting two metal pipes (max diameter 33 mm, min thickness 3.2 mm) in the special holes in the base and use suitable lifting means.



The weight of the unit is unbalanced towards the compressor side (electrical panel side).



During transport, the unit must always be kept in a vertical position.



Handling must be performed by qualified personnel, adequately equipped and with tools that are suitable for the weight of the unit.

Instructions for lifting

- Make sure that all the panels are well fixed before moving the unit.
- Before lifting, check the weight of the unit on the CE label.
- Use all the lifting points indicated, and only those.
- Use ropes of equal length.
- Handle the unit with care and without jerky movements.

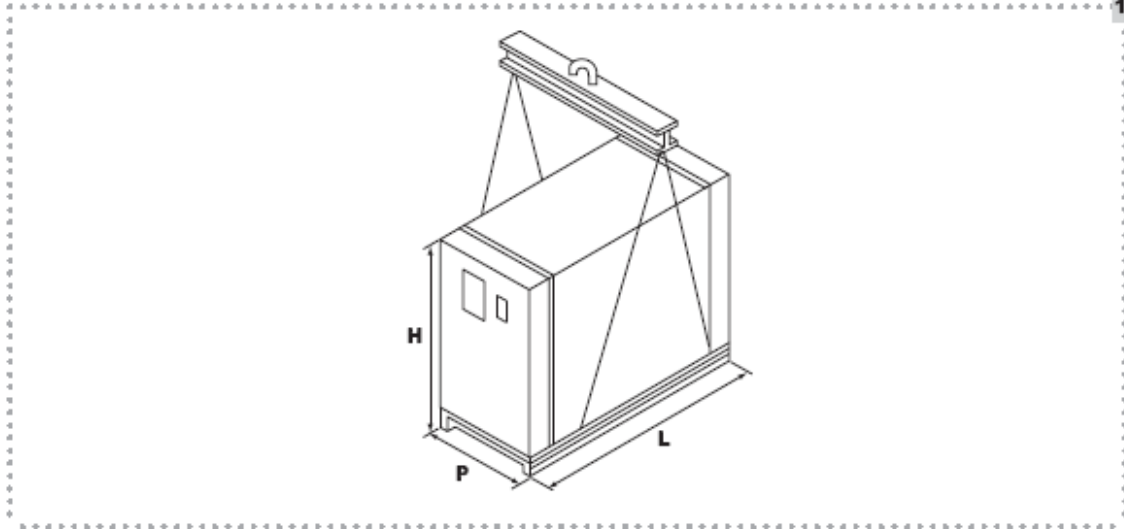

2.12 POSITIONING

The position of the **ARIA** appliances must be decided by the system designer or by a suitable expert and must consider both the purely technical issues and any local legislation in force which foresees special authorisations (e.g. urban planning, building regulations, environmental pollution etc.).

It is therefore advisable to obtain all necessary authorizations before starting the installation.

The appliances must be:

- Positioned on a flat surface capable of supporting the weight.
- Positioned on a slab that is sufficiently rigid and that does not transmit vibrations to any rooms that are adjacent or below.

It is advisable to place a rubber mat between the appliance and the slab (hardness 60 shores, thickness 10 mm) or use the antivibration damper supports available as accessories.

The unit is designed to be installed outside and must be placed in a safe area as shown in the figure below.

The spaces indicated are necessary to avoid air currents and allow normal cleaning and maintenance operations.

It is advisable to avoid:

- installation in wells or enclosed areas
- obstacles or barriers that could cause the recycling of expelled air
- installation in areas with aggressive atmospheric conditions
- installation in narrow areas where the noise level of the appliance could be amplified by reverberations or resonance
- installation in areas subject to the accumulation of dust, leaves or anything that could reduce the efficiency of the appliance by obstructing the air flow
- situations where the expulsion of air from the appliance can penetrate into adjacent inhabited areas through doors or windows, provoking inconvenience to persons.

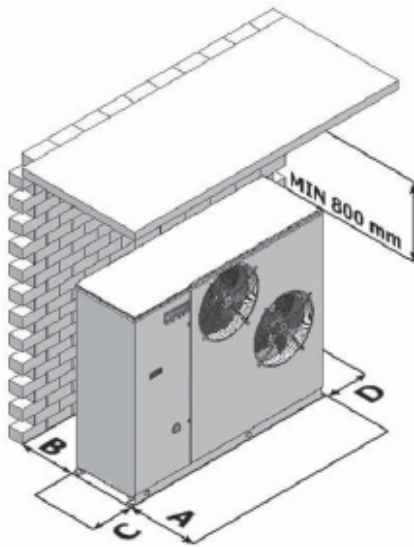

Dimensions (mm)	6HP 8HP	11HP
A	1000	1200
B	500	600
C	1000	1000
D	600	800



In the case of several appliances side by side on the battery side, add up the safety distances.



When the snow hood is present, recalculate the distances with the accessory installed.



Do not position the appliances with the inlet of the fan of the first towards the finned battery of the second.

2.12.1 Fixing position of dampers

See figure 20 with the relative models.

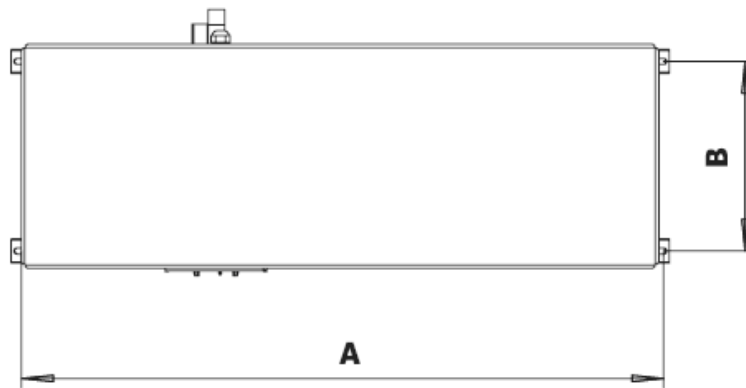

ARIA 6HP/8HP	A (mm)	1070
	B (mm)	325
ARIA 11HP	A (mm)	1270
	B (mm)	375

2.13 HYDRAULIC CONNECTIONS

The choice and installation of components must be made by the installer who acts in accordance with good technical code of practice and legislation in force.

Before connecting the pipes, ensure that they do not contain pebbles, sand, rust, waste or foreign bodies that could damage the system.

Hydraulic diagram for connection to the system

- ARIA 6HP / 8HP (fig. 21)

- ARIA 11HP (fig. 22)



For the electrical connection of the 3-way valves see the ACS thermostat kit instructions

21

ARIA 6HP/8HP Models

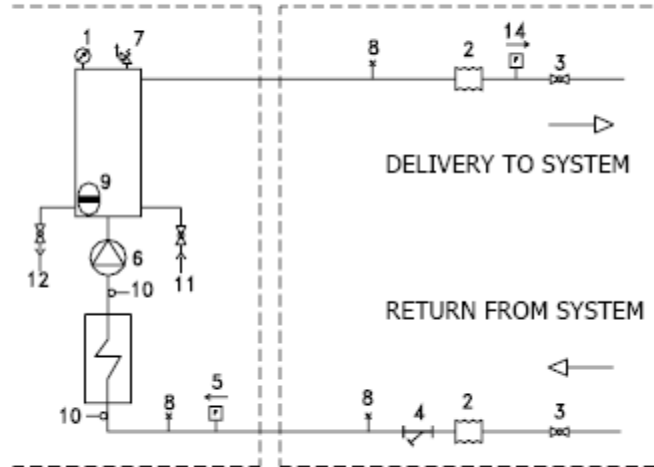

Legend fig. 21/22

1	Pressure gauge	8	Air breather
2	Anti-vibration joint	9	Expansion tank
3	Interception valve	10	Temperature probe
4	Net filter	11	Load/Reintegration
5	Flow controller	12	Discharge tap
6	Pump	13	Calibration bypass
7	Safety valve	14	Flow switch

22

ARIA 11HP Model

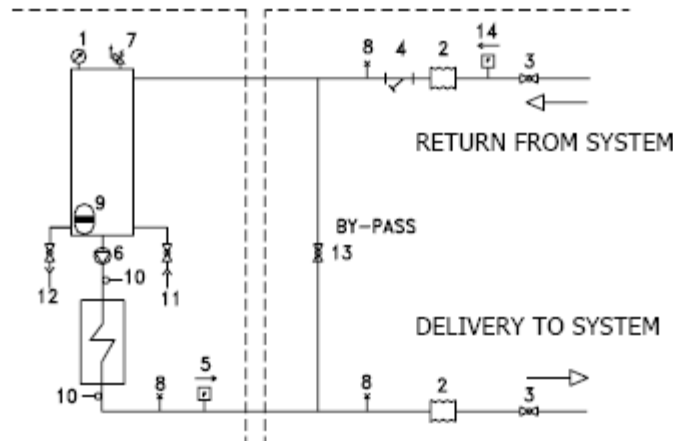

Hydraulic connections must be completed by installing:

- a 0.5 mm metallic net filter in inlet (system return)
- a flow meter in outlet (inlet to the system) for liquids to be sized and adjusted based on the hydraulic characteristics of the system; to be installed half-way along a horizontal straight pipe section, at least 1 metre long.

Together with the flow regulator, installed on board the machine, it must guarantee the correct flow-rate of water in transit in the appliance (with ΔT minimum 4°C and maximum 6°C);



Special supply/particle reintegration waters must be conditioned with suitable treatment systems. The values shown in the table can be considered as reference values:

REFERENCE VALUES	
PH	6÷8
Electrical conductivity	less than 200 mV/cm (25°C)
Chlorine ions	less than 50 ppm
Sulphuric acid ions	less than 50 ppm
Total iron	less than 0.3 ppm
M alkalinity	less than 50 ppm
Total hardness	less than 50 ppm (5 °F)
Sulphur ions	none
Ammonia ions	none
Silicon ions	Less than 30 ppm

ppm = parts per million

- air breather valve in the highest parts of the pipelines;
- flexible elastic joints;
- interception valves;
- interception valves for chemical wash.



The calibration by-pass must be inserted downstream of the machine for greater adjustment of the system flow-rate and prevalence.



Install a load/reintegration system and a unit discharge system to be connected in the lowest part of the hydraulic circuit.



Systems with antifreeze or particular legislative dispositions require obligatory water disconnect devices. If filters, flow-meter and dampers are not installed this can cause

obstruction, breakage and noise problems for which the manufacturer accepts no responsibility.



The units are fitted with circulation pumps as standard.



The water flow-rate must be kept constant during operation. The water contained in the system must be sufficient to prevent unbalances in the cooler circuit operation (see tables on page 8).

2.14 POSITION OF THE FIXINGS

M Inlet to the system
R return from the system
r water reintegration

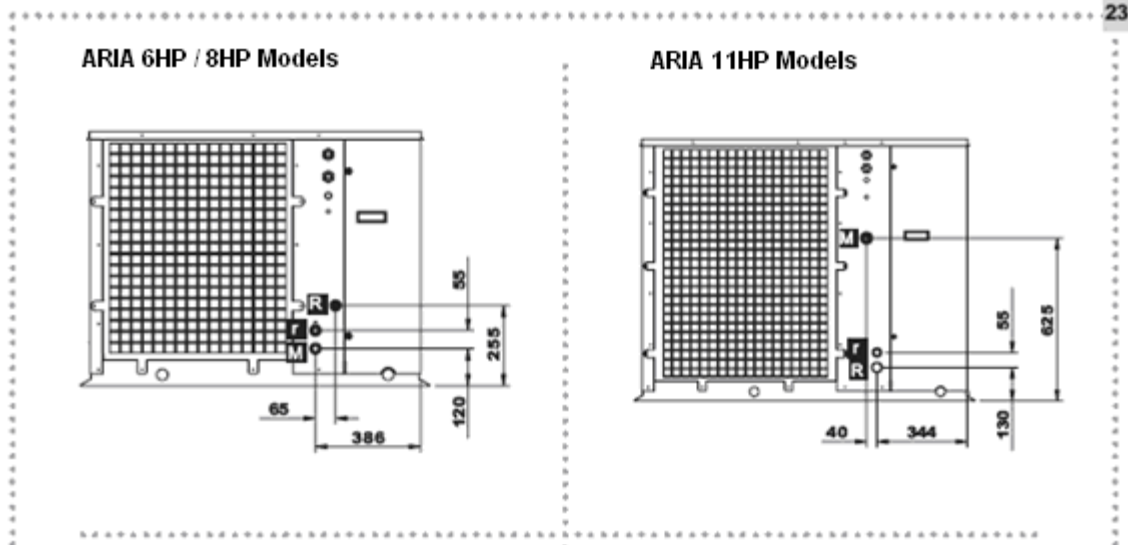

24

TABLE FOR THE SIZING OF THE POWER SUPPLY LINE

Models	Power supply voltage (V-ph-Hz)	Max Power absorbed (kW)	Max current absorbed (A)	Peak current (A)
6HP	230 - 50	2.72	14.6	58
8HP	230 - 50	3.75	19.0	82
11HP	230 - 50	4.66	27.8	97

2.15 ELECTRICAL CONNECTIONS

The **ARIA** heat pumps leave the factory completely wired and only require connection to the mains electrical supply and connection of the flow-meter which must be done by qualified personnel in compliance with legislation in force. For all electrical connections, refer to the wiring diagrams in this booklet.

The following checks are also recommended:

- Check that the characteristics of the mains electric supply are adequate to the absorption indicated in the electrical characteristics table shown below, also considering any other appliances in parallel operation.
- Check that the mains supply corresponds to the nominal value +/- 10%.



For electrical connections use double insulation cables.



It is compulsory:

- to use a double pole thermal magnetic master switch to protect the power line
- to make an efficient earth connection.



It is forbidden to use the gas or water pipes to make the earth connection.



The manufacturer is not responsible for any damage caused by a lack of earth connection or by the failure to observe the indications in the wiring diagrams..



ATTENTION:

FOR THE SIZING OF THE POWER SUPPLY LINE, IN ADDITION TO THE POWER VALUE SHOWN IN THE TABLE ABOVE, ALSO CONSIDER THE ELECTRICAL RESISTANCE VALUE IN PAGE 8 (TECHNICAL DATA).

2.16 OUTSIDE CONNECTIONS AND ELECTRICAL POWER CABLE INFIED

The appliance is supplied with suitable cable clamps for the passage of the mains power supply cables and the other electrical connections.

- Insert the mains power supply cable in the larger cable clamp

- Insert the cables from outside, routing them towards the electrical panel.



Avoid direct contact with the un-insulated copper pipes and with the compressor.



It is forbidden to insert the electrical cables from the appliance in positions not specified in this manual.



THE APPLIANCE MUST ALWAYS BE ELECTRICALLY POWERED TO ALLOW A CORRECT PRE HEATING OF THE COMPRESSOR OIL. IT IS COMPULSORY TO

KEEP THE APPLIANCE POWERED FOR AT LEAST 8 HOURS BEFORE THE FIRST START-UP.

The electrical panel with the connection terminal board is situated inside the appliance, in the upper part of the technical area dedicated to circuit components.

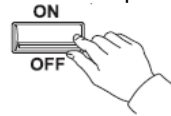

Before starting operations, set the master switch on the system to "OFF".

25

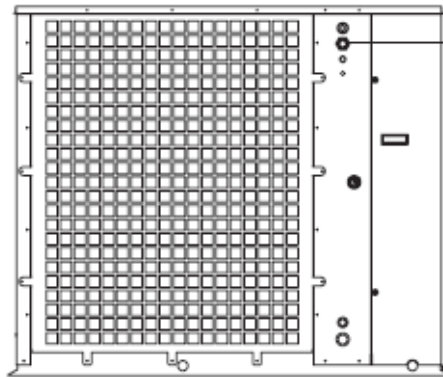

Cable clamps for outside connections and power line infeed

To make the electrical connections:

- Unscrew the four screws on the inspection panel (fig. 26 ref. A)
- Remove the panel (fig. 26 ref. B)
- Set the master switch A to "OFF" (fig. 26 ref. C)
- Insert the main power supply cable in hole (fig. 26 ref. D) and the outside connection cables in hole (fig. 26 ref. E).

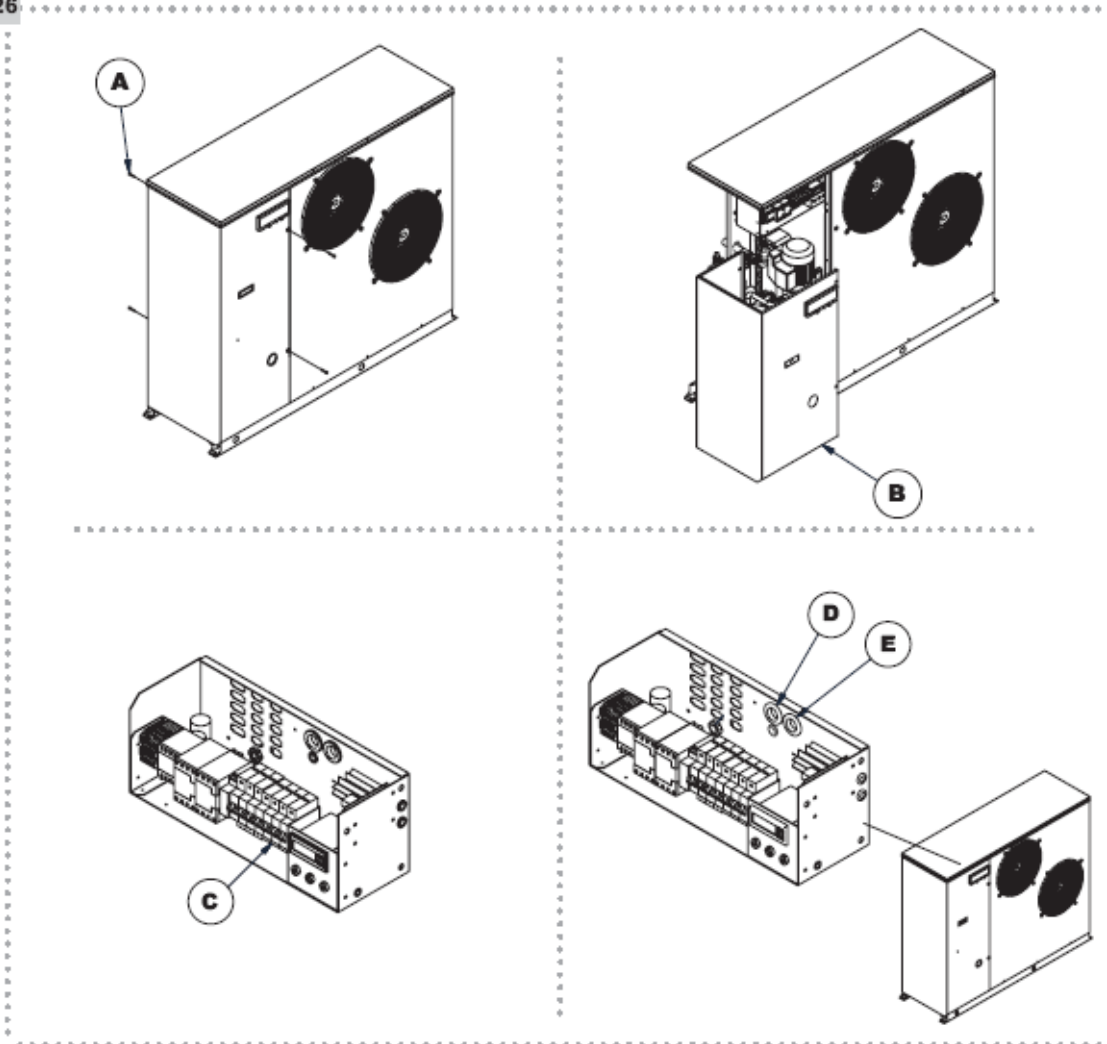

- Make the connections as indicated in figure 27
 FL Outside flow switch
 SEI Remote summer winter switch
 SO Remote ON-OFF switch
 AL Remote alarm signal (output 12V DC - max
 20mA)

When the connections are completed, block the cables with the cable clamps, turn the master switch to ON and remount the inspection panel with the special fixing screws.

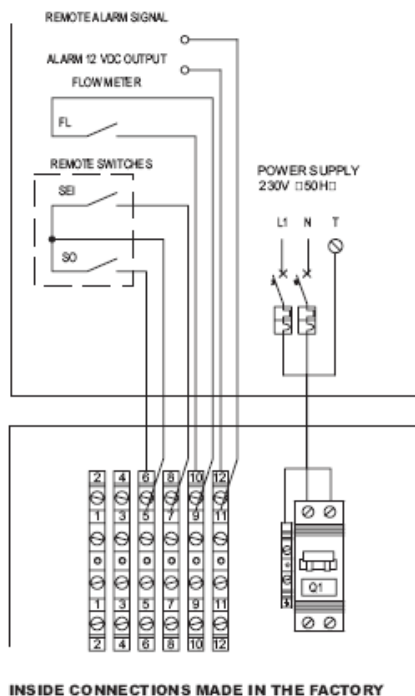
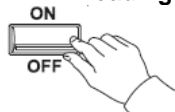
OUTSIDE CONNECTIONS (INSTALLER RESPONSIBILITY)**2.17 LOADING AND EMPTYING THE SYSTEM****2.17.1 Loading**

- Before starting the loading set the master switch on the system to "OFF".
- Check that the discharge taps on the unit and the system are all closed.
- Open all the breather valves on the unit, on the system and on the relative terminals.
- Open the system interception devices.
- Start filling by slowly opening the system water filling tap (fig. 28 ref. A) positioned outside the unit.
- When water starts coming out of the breather valves, close them and continue filling until reaching the pressure envisaged for the system.



Check that the gaskets are watertight.



It is advisable to repeat this operation after the unit has been functioning for a few hours and then periodically check the pressure in the system. The reintegration must be carried out with the machine switched "OFF" (pump "OFF").



The system must be loaded to a pressure of between 1 and 2 bar that can be checked on the pressure gauge on the unit.

2.17.2 Emptying.

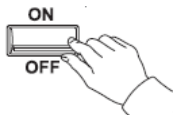
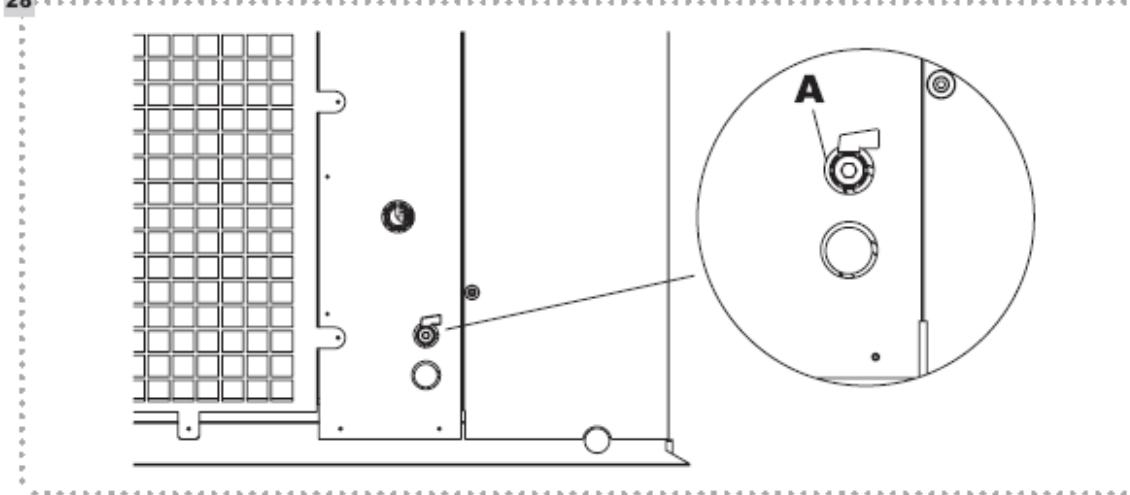

- Before starting the emptying set the master switch on the system to "OFF".
- Check that the system water reintegration/ loading tap is closed (fig. 28 ref. A)
- Open the inspection panel on the front of the unit.
- For the 11HP model open the by-pass valve (to be installed downstream of the machine), the unit discharge tap, the discharge taps on the system and all the breather valves.
- For models 6HP and 8HP open the two discharge taps on the unit, the system discharge taps and all the breather valves.



If the system contains antifreeze, it must not be freely emptied because it is a pollutant. It must be collected and eventually re-used.

3 TECHNICAL SERVICE

3.1 RECOMMENDED OPERATING CONDITIONS

For perfect operation of the unit, the advisable conditions must be respected:

OPERATING CYCLE	OUTLET WATER TEMP.		OUTSIDE AIR TEMP	
	min.	max.	min.	max.
Cooling	+7°C	+18°C	15°C	+42°C
Heating	+35°C	+45°C	-15°C	+25°C

3.2 LIMIT OPERATING CONDITIONS

For perfect operation of the unit, it is advisable to operate within the area "A".



It is possible to operate in the area "B", by modifying the operating parameters of the unit.



Do not operate outside areas "A" and "B".

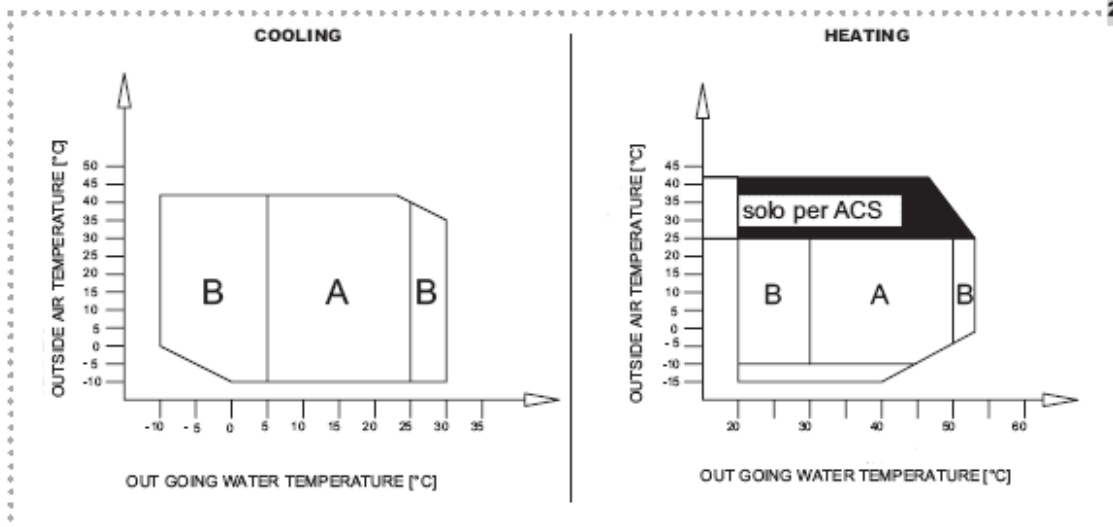

3.3 PREPARATION FOR THE FIRST STARTING UP

The first starting up of the unit must be carried out by the Vokera technical service.

Before starting up the unit, ensure that:

- All the safety conditions have been respected.
- The unit has been suitably fixed to the support surface.
- The safety area has been respected.
- The hydraulic connections have been made according to the instruction manual.
- The hydraulic system has been loaded and purged.
- The interception valves in the hydraulic circuit are open.
- The electrical connections have been made correctly.
- The voltage is within a 10% tolerance of the nominal value of the unit.
- The earth connection has been made correctly.
- All the electrical connections have been made correctly.

3.4 FIRST START-UP



THE APPLIANCE MUST ALWAYS BE ELECTRICALLY POWERED TO ALLOW A CORRECT PRE-HEATING OF THE COMPRESSOR OIL. IT IS COMPULSORY TO KEEP THE APPLIANCE POWERED FOR AT LEAST 8 HOURS BEFORE THE FIRST START-UP.

Before activating the appliance, ensure that:

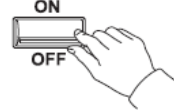

- Set the master switch on the system to "OFF".

- Remove the inspection panel (fig. 30 ref. A), removing the four fixing screws (fig. 30 ref. B)

- Set the master switch on the unit (fig. 31 ref. A) to "ON"

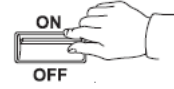

- Set the master switch on the system to "ON".

- Check that the Display is on and signals the system return temperature.

30

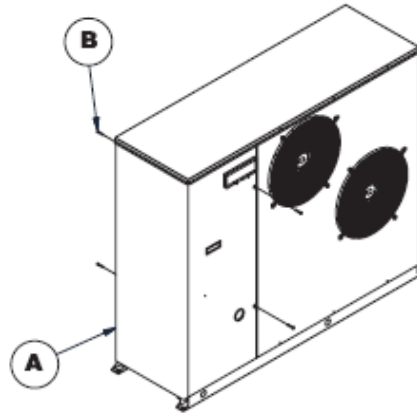

- Keep the unit powered but not operating for at least two hours to allow the oil in the compressor to heat up.

- Switch on the unit.



For the correct position of the inside components, refer to pages 10 to 12.

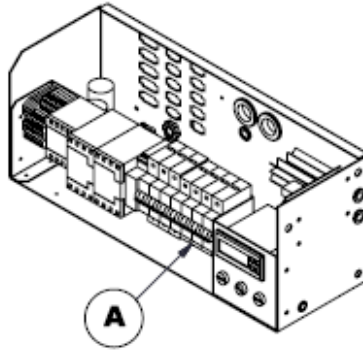

3.6 ACTIVATION OF “SO” and “SEI” CONTROL

PERFORM THE FOLLOWING OPERATIONS FROM THE CONTROL PANEL:

The operations described below must be carried out with maximum attention to avoid compromising the working efficiency of the unit. If errors are made or if there are uncertainties concerning the interpretation during the operations,

WAIT FOR 15 SECONDS WITHOUT PRESSING ANY KEY.

To activate the SO and SEI control, proceed as follows:



- Power up the unit, setting the system master switch and the unit master switch to “ON”.

If it is the first start-up, “OFF” will appear on the

display. In this case, press the  key to set the machine in standby.

At this point the return temperature value will appear on the display.

3.6.1 Setting the “SO” remote control (on - off):

- Now press the  and  keys simultaneously to access the user parameters. “Par” will appear on the display to indicate access to the user parameters.

- Now press the  key to access the CF menu.

- CF appears on the display to indicate the remote controls parameter menu.

- Press the key and CF19 appears, with the  arrow key move to CF20, which indicates the “SO” parameter, that is, remote summer/winter change.



To set the remote SO control, just press  and move the value from 0 to -13 (minus 13);

then confirm with  the key.

- Press the key, until the display indicates the temperature of the return water.

- Cut off the power to the machine to memorise the value. Power it back up and check with the key.

3.6.2 Setting the “SEI” remote control (change summer – winter cycle):

- Now press the  and  keys simultaneously to access the user parameters. “Par” appears on the display to indicate access to the user parameters.

- Now press the  key to access the CF menu.

- CF appears on the display to indicate the remote controls parameter menu.

- When the  key is pressed CF19 appears, that indicates the “SEI” parameter that is, remote summer/winter change.

To enable the remote control, just press  and move the value from 0 to -14 (minus 14)

(using the arrows); then confirm with the  key.

- Press the  key, until the display indicates the temperature of the return water.



3.7 ANOMALY SIGNALS

In case of a malfunction of the unit, codes will appear on the control panel display, consisting of letters and numbers alternating with the system return temperature. Part of the alarms reset automatically while others must be reset with the manual intervention of the Manufacturers Technical Service.

DESCRIPTION	SIGNAL	RESET DISPLAY
High pressure	Er01	manual
Low pressure	Er05	manual
Flow switch	Er20	manual
Water circuit antifreeze	Er30	automatic
High water temperature (< 60°C)	Er35	automatic
Clock fault error	Er45	
Clock to be adjusted error	Er46	
Inlet temperature probe	Er60	automatic
Outlet temperature probe	Er61	automatic
Outside temperature probe fault	Er68	automatic
Condensation pressure probe	Er75	automatic
Configuration error	Er80	automatic
Compressor working hours exceeded	Er81	manual
Pump working hours exceeded	Er85	manual
Alarms archive recordings exceeded	Er90	manual

3.7.1 Manual anomaly reset

After having cleared the cause that provoked the anomaly, reset as follows:

Simultaneously press the UP  and DOWN  keys to reset the alarms.

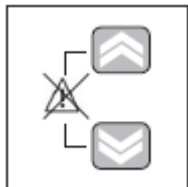

3.8 ACTIVATION and DEACTIVATION of the UNIT

To perform the ACTIVATION and DEACTIVATION of the "COOLING" and "HEATING" functions act on the CONTROL PANEL installed on the machine, or on the two REMOTE ON-OFF (SO) and SUMMER-WINTER (SEI) SWITCHES if installed.

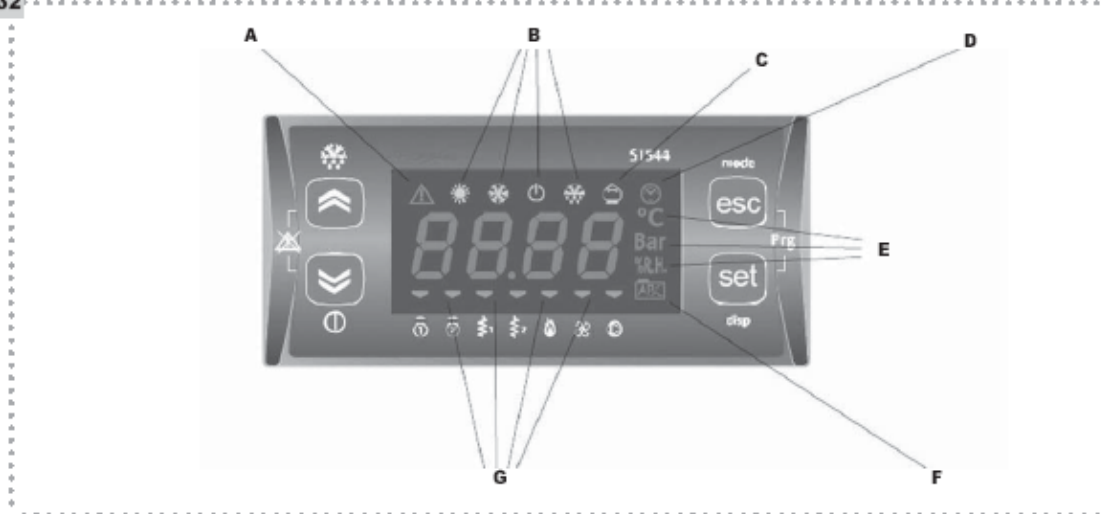

Fig. 32

- A Alarm
- B Mode (Heat, Cool, etc....)
- C Economy (settable)
- D Clock
- E Unit of measure
- F Navigation in the menu icon
- G Resources (Compressor, Fans, etc....)



If the code "Er 20" appears on the display during this first phase, proceed as follows:

- Check the water flow-rate and the connection to terminals 9 and 10 of the flow-meter.

To access the control panel, open the inspection flap (fig. 33 ref. A):

- Remove the locking screw
- Simultaneously press on points B (fig. 33 ref. B) and lift the flap (fig. 33 ref. C)

When the operations on the control panel are completed:

- Close the flap and reposition the locking screw.



Activation

To select the operating mode, hold down the



key until the message "HEAT", "COOL" or "STBY" appears, according to the current operating status of the controller.

Select the HEAT function with UP  or

DOWN  and confirm with the  SET key.

Heating (WINTER CYCLE)



By selecting HEAT the  symbol lights up.



The change in the operating mode from Heating to Cooling must only be carried out with the temperature of inlet water to the exchanger plate lower than 20°C.



The change in the operating mode from Cooling to Heating must only be carried out with the temperature of inlet water to the exchanger plate higher than 20°C.



Limit the change in the operating mode to once per day.

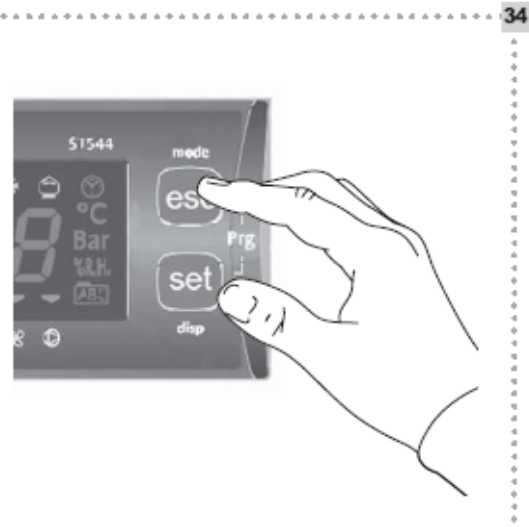
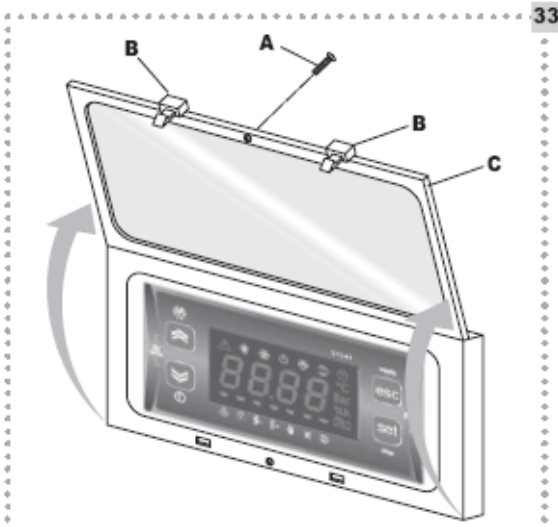



Cooling (SUMMER CYCLE)

By selecting COOL the  symbol lights up.

Deactivation Heating/Cooling

Select the STBY option and confirm with the SET  key.

The  symbol lights up.

 In case of a power failure lasting more than four hours, when power returns, keep the unit powered but deactivated for at least eight hours.

 In case of a power failure lasting less than four hours, when power returns, keep the unit powered but deactivated for the same number of hours that the power was out.

3.9 OPERATIONS PERFORMED BY THE ON-OFF "SO" and SUMMER-WINTER "SEI" REMOTE SWITCHES (IF PRESENT)

Cooling Function

Activation

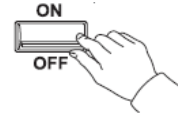

- Position the SUMMER-WINTER remote switch (SEI) to "OFF"

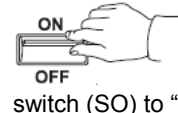

- Position the ON-OFF remote switch (SO) to "ON".

The  warning LED lights up on the control panel.



Deactivation

- Position the ON-OFF remote switch (SO) to "OFF".

35



 The message "OFF" flashes on the CONTROL PANEL.

  The warning LED lights up on the control panel.

Heating Function

Activation

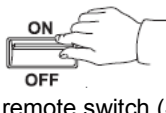

- Position the SUMMER-WINTER remote switch (SEI) to "ON"

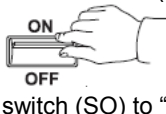

- Position the ON-OFF remote switch (SO) to "ON".

Deactivation



- Position the ON-OFF remote switch (SO) to "OFF".

 The message "OFF" flashes on the CONTROL PANEL



In case of a power failure lasting more than four hours, when power returns, keep the unit powered but deactivated for at least eight hours.



In case of a power failure lasting less than four hours, when power returns, keep the unit powered but deactivated for the same number of hours that the power was out.



Limit the change in the operating mode to once per day.

3.10 DEFROSTING CHECK

To avoid the formation of ice on the finned battery during the winter heating phase, each machine is fitted with an automatic defrosting device, managed by the microprocessor through the pressure probes and timer.



During the defrosting procedure, the symbol flashes on the control panel indicating the defrosting status.

3.11 CONTROLS DURING AND AFTER THE FIRST START-UP

When the start up is completed, check that:

- The current absorbed by the compressor is less than that indicated in the technical data table
- The unit operates within the recommended operating conditions (see page 45).
- The hydraulic circuit is completely purged of air
- The unit stops and the restarts.

3.12 LONG TERM SHUTDOWN

From the control panel, deactivate the heat pump from whichever mode it is operating in.

After deactivating the unit:

- Set the remote switch to "OFF" (if present)
- Deactivate the indoor terminal units by setting the switch on each appliance to "OFF".
- Set the master switch on the system to "OFF".
- Close the water taps.



If there is a possibility that the outside temperature falls below zero there is a risk of freezing.

The hydraulic system **MUST BE EMPTIED** or else antifreeze liquid (e.g. ethylene glycol) must be added in the doses suggested by the manufacturer of the liquid.



If the unit is connected to a boiler in parallel, during its operation, close the taps on the unit. The temperature of the water circulating in the heat pump must never exceed 60°C.

3.13 ROUTINE MAINTENANCE

Routine maintenance is essential to keep the **ARIA** heat pump in perfect working order, from both a functional and energy efficiency aspect.

The maintenance plan that the Vokera technical service will perform annually, envisages the following checks and operations:

- Check the expansion tank pressure (2 bar)
- Water circuit filling-up
- Air presence in the water circuit
- Working efficiency of safety devices
- Power supply voltage
- Electrical absorption
- Tighten electrical connections
- State of the compressor contactor
- Plate exchanger resistance efficiency
- Compressor resistance efficiency
- Cleaning of finned battery (*)
- Cleaning of fan grills
- Cleaning of condensation collection bowl (if installed).

(*) every three months.

For appliances installed close to the sea, the maintenance intervals should be halved.

During maintenance operations, it might be necessary to remove the inspection panels on the cooler. In this case, proceed as follows:

- Unscrew the fixing screws and remove the panels.
- When the maintenance operations have been completed:
- Remount the panes, proceeding in the reverse order.

3.14 EXTRAORDINARY MAINTENANCE

3.14.1 Loading coolant gas

The **ARIA** heat pumps are pre-loaded with R410A coolant gas and adequately tested in the factory. In normal conditions they do not require any intervention by the Manufacturers Technical Service to check the coolant gas. However, over time small leaks could develop in the joints allowing the gas to leak and discharge the circuit, causing a malfunction of the appliance. In this case, the leaks must be found and repaired and the cooling circuit must be washed with nitrogen or with specific products and recharged as follows:

- Empty and dehydrate the entire cooling circuit using a vacuum pump connected both to the low pressure and high pressure sockets until the vacuum gauge shows 10 Pa. Wait at least 5 minutes and check that this value does not rise over 200 Pa.
- Connect the coolant gas cylinder or a recharging cylinder to the liquid line socket.
- Load the quantity of coolant gas, in liquid phase, indicated on the technical plate of the unit.
- Always check the overheating and undercooling values of the appliance which, in nominal operating conditions must be respectively between 6 and 10°C (OVERH), and maximum 2 °C (UNDERH). After a few hours of operation, check that the flow indicator indicates a dry circuit (dry - green).



If the operating conditions are different from the nominal ones, this could give values that are very different.



The coolant must only be loaded in liquid phase.



The test of the seal or search for leaks must only be performed using coolant gas R 410A, possibly mixed with nitrogen, and checking with an adequate leak detector.



It is forbidden to load the coolant circuits with a coolant that is not R410A. Use of a coolant different from R410A could seriously damage the compressor.



It is forbidden to use oxygen or acetylene or other inflammable or poisonous gases as they could cause explosions.

In case of breakages, if the compressor can be repaired only use original oils.



Do not use oils other than those indicated. The use of different oils could seriously damage the compressor.

Characteristics

3.14.2 Compressor

The compressor is installed on the machine already loaded with oil and sealed. Normally it does not require any particular interventions from the Vokera technical service.

3.15 DISPLAY AND CONTROL PARAMETERS

3.15.1 Main parameters and variable

The control panel of the unit gives direct access to the main control parameters and the display of some variable characteristics of the unit.

DESCRIPTION	SIGNAL	FACTORY ADJUSTMENT
	DISPLAY	VALUE
Summer Set Point	COOL	15
Summer Differential	tr10	3
Winter Set Point	HEAT	40
Winter Differential	tr11	3
Return Water Temperature	Ai01	DISPLAY ONLY
Inlet Water Temperature	Ai02	
Condensation Pressure	Ai03	
Outside Temperature	Ai04	



The perfect operation of the unit is obtained by respecting the factory regulations and in any case, keeping within the permitted ranges.



3.15.2 Access and Modification of Parameters

The unit must be electrically powered and the display must show the temperature of water that returns from the system, or the message "OFF".

To access and eventually modify the parameters, perform the following procedure:

Access to the various menus - parameters

- When the set  key is pressed, Ai is shown on the display to indicate the pressure and temperature parameters menu.

Scroll with the  and  keys to access other parameter menus: A0 (output status), CL (clock and date parameters), SP variable parameters set-point, Sr (real non-variable setpoints – display only).

Modification of heat and cool set-points

To modify the inlet water temperature set-point (return from the system), proceed as follows:

- When the **set** key is pressed, the first Ai menu is shown on the display, with the **↑** key go to the **SP** menu and press the **set** key. At this point, the message **COOL** appears, to indicate the summer set point. To modify the summer set point, press the key, and with the **↑** and **↓** keys change the previously set value. To confirm, press the **set** key.

Then press **esc** to exit. To modify the winter set point, proceed as above.

When **COOL** appears, press the **↑** key to access **HEAT** (winter set-point), press **set** and change the parameter with the **↑** and **↓** keys.



Save and Exit

- To save the parameters, it is always advisable to cut off the power supply and then power back up. The display will indicate the "return water temperature".

Modification of the temperature differentials in heat and cool

To modify the temperature differential of the two cycles, proceed as follows:

- Press the **set** and **esc** keys simultaneously.

PAR is shown on the display.

- Now press the **set** key to access the **CF** menu.

- Press the **↑** key to access the **tr** menu, then **set** to access **tr10** that indicates the temperature differential for the summer cycle.

Press **set** again to access the parameter and use the arrows keys to modify the differential value.

Press the **set** key to confirm.

Press **esc** to exit.



- To modify the temperature differential of the winter cycle, go to the **tr10** parameter (see previous point).

- Press the **↑** key until parameter **tr10** appears and with the **↑** key go to the **tr11** parameter.

Now press the **set** key to access the parameter and with the arrow keys change the value of the differential.

- Press the **esc** key, until the value of the value of the return water appears on the display.



Save and Exit

- To save the parameters, it is always advisable to cut off the power supply and then power back up.

- The display will indicate the "return water temperature".

3.16 TROUBLESHOOTING

In case of a malfunction of the unit, codes will appear on the control panel display, consisting of letters and numbers (e.g. Er01) alternating with the system return temperature. Part of the alarms reset automatically while others require a manual intervention, pressing the UP and DOWN keys (see page 30).

AUTOMATIC ANOMALY RESET

When the alarm cause is cleared, the control panel automatically returns to the normal operating mode.

ANOMALY	CAUSE	REMEDY
The compressor does not start	Power supply voltage too low. Circulator broken or clogged. Electrical connections badly tightened.	Check
	Contacteur coil fault. Broken electronic card. Condenser peak failure (single phase version). Compressor failure.	Replace the compressor
	LED phase monitor "OFF". (three-phase version).	Invert two phases
The compressor stops following safety device intervention	Excessive inlet pressure (Er01). Low suction pressure (Er05). Insufficient flow-rate or system not purged (Er020). Circulator broken or clogged (Er020).	Check
	Poor flow-meter operation. Compressor motor fault.	Replace the component
Insufficient Performance	High discharge pressure. Low suction pressure. Incorrect thermostat calibration. Unit sizing.	Check
Noisy Compressor	Fluid return to the compressor. Inadequate fixing.	Check

MANUAL ANOMALY RESET

After having cleared the cause that provoked the anomaly, reset by pressing simultaneously the UP and DOWN keys.

Noises and Vibrations	Contact between metallic bodies.	Check
	Weak foundations.	Reset
	Loosened screws	Tighten the screws
Low Discharge Pressure	Low condensation air/water temperature.	Check
	Fan adjustment malfunction. Insufficient coolant load.	
	Compressor discharge valve leak.	Replace the component
High Suction Pressure	High inlet water temperature. Thermostatic expansion valve broken or open.	Check
Low Suction Pressure	Low inlet water temperature. Thermostatic expansion valve broken or clogged. Suction line obstructed. Clogged filter. Evaporator exchanger clogged. Excessive quantity of antifreeze in the water circuit.	Check



Registered address:

Vokèra Ltd
Borderlake House
Unit 7 Riverside Industrial Estate
London Colney
Herts AL2 1HG

enquiries@vokera.co.uk

www.vokera.co.uk
www.vokera.ie

Sales, General Enquires

T 0844 391 099

F 0844 391 0998

Vokèra Ireland
West Court, Callan
Co Kilkenny
T 056 7755057
F 056 7755060

Vokèra Limited reserve the right to change
specification without prior notice
Consumers statutory rights are not affected.

A Riello Group Company.
Company Reg No: 1047779